

# Ohio

# SITS



# Ohio

## UPHOLSTERY



fabric



leather

## COMFORTS



STD standard



LUX lux



PRE premium



CLS classic

## COVERS



FC fixed

## SPECIAL



modular system

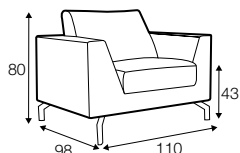

armchair

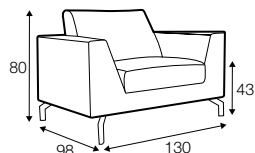

armchair wide

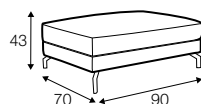

footstool 90x70

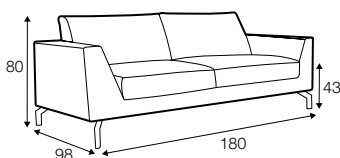

2 seater

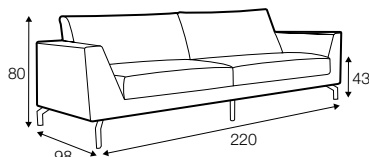

3 seater

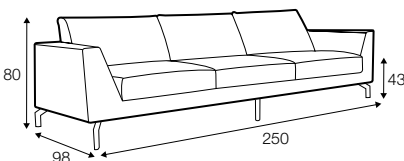

3 XL seater

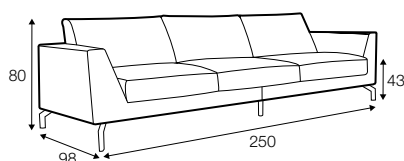

3 XL seater divided

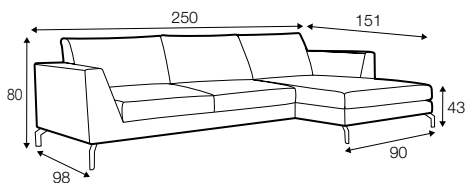

set 1 right / or left

2 seater left / or right + chaiselongue right / or left

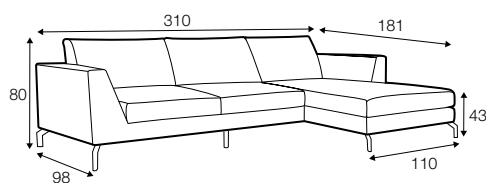

set 2 right / or left

3 seater left / or right + chaiselongue long right / or left

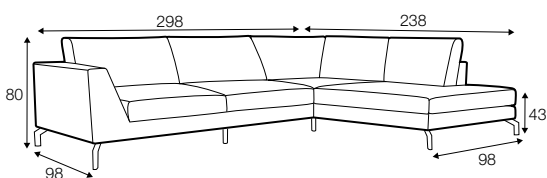

set 10 right / or left

3 seater left / or right + corner 90° + bench right / or left

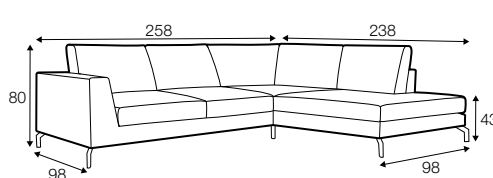

set 11 right / or left

2 seater left / or right + corner 90° + bench right / or left

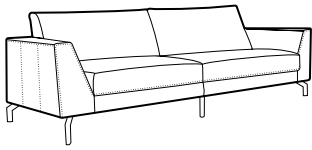

example of leather cover  
3 seater

### modular system

---

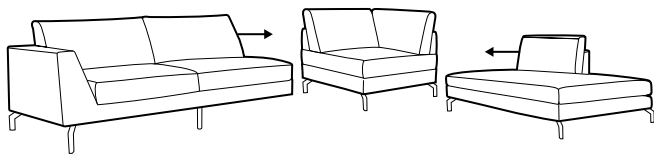

### elements of the modular system

---

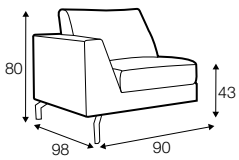

armchair left / or right

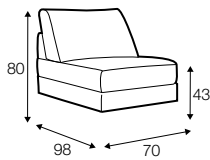

armchair  
without armrests

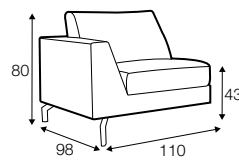

armchair wide left / or right

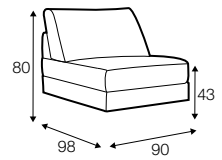

armchair wide  
without armrests

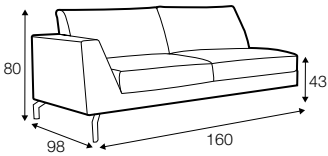

2 seater left / or right

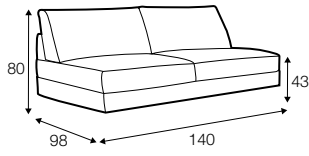

2 seater without armrests

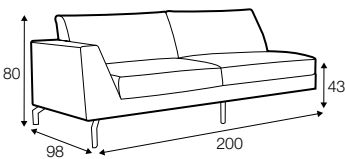

3 seater left / or right

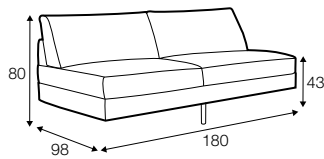

3 seater without armrests

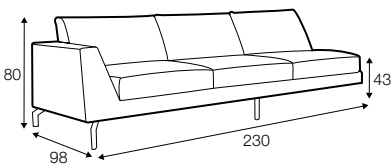

3 XL seater left / or right

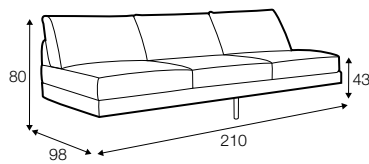

3 XL seater without armrests

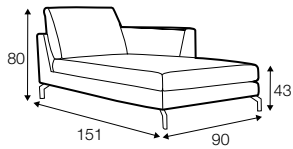

chaiselongue right / or left

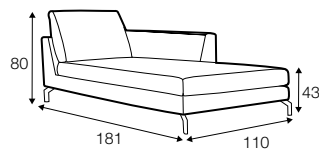

chaiselongue long right / or left

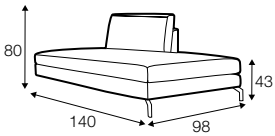

bench right / or left

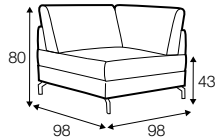

corner 90°

## extra dimensions

---

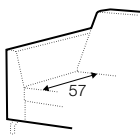

depth of seat

## legs

---

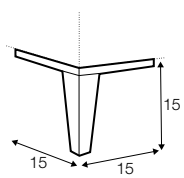

no. 152  
wood

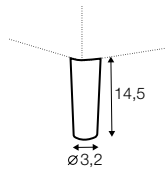

no. 153  
wood

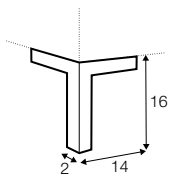

no. 47  
metal chrome,  
painted black or grey  
and brushed steel\*

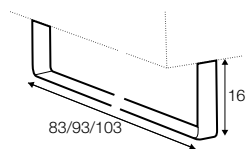

no. 104  
metal chrome,  
painted black or grey

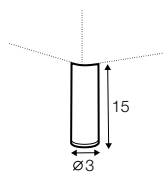

no. 111D  
metal chrome,  
painted black or grey  
and brushed steel\*

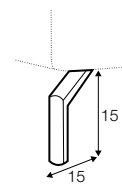

no. 119  
metal chrome,  
painted black or grey  
and brushed steel\*

\*please check a cost of brushed steel finish with a sale representative.

## profile

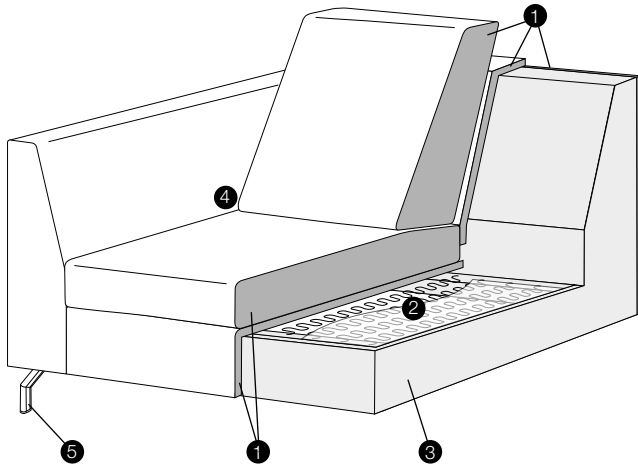

### standard

1. polyurethane foam/high resilient polyurethane foam
2. springs
3. FSC® certified solid wood and wood based elements
4. fabric or leather
5. FSC® certified solid wood or metal legs

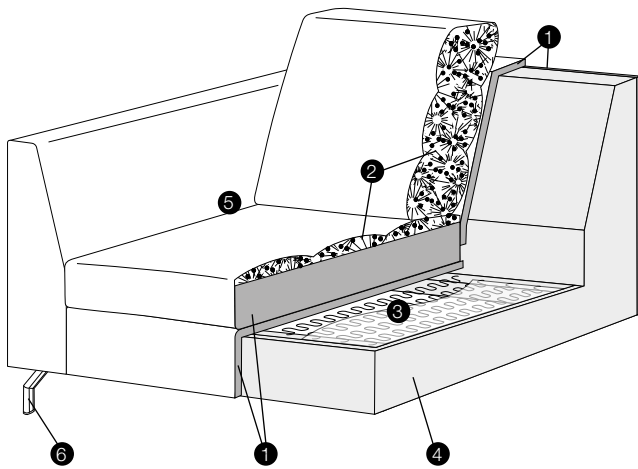

### lux

1. polyurethane foam/high resilient polyurethane foam
2. cushion chamber with mix of feather and silicone balls
3. springs
4. FSC® certified solid wood and wood based elements
5. fabric or leather
6. FSC® certified solid wood or metal legs

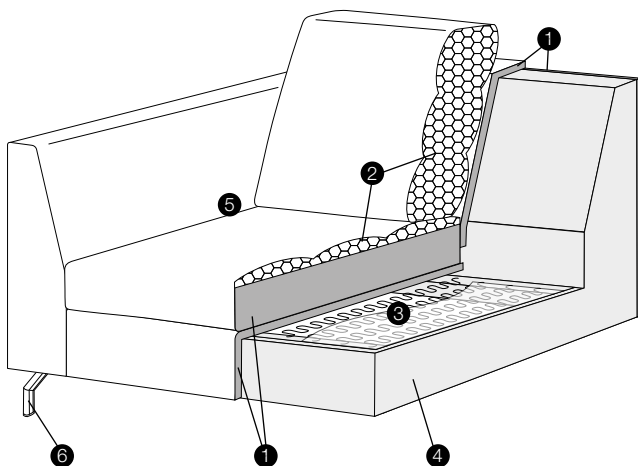

### premium

1. polyurethane foam/high resilient polyurethane foam
2. silicone balls
3. springs
4. FSC® certified solid wood and wood based elements
5. fabric or leather
6. FSC® certified solid wood or metal legs

## profile

---

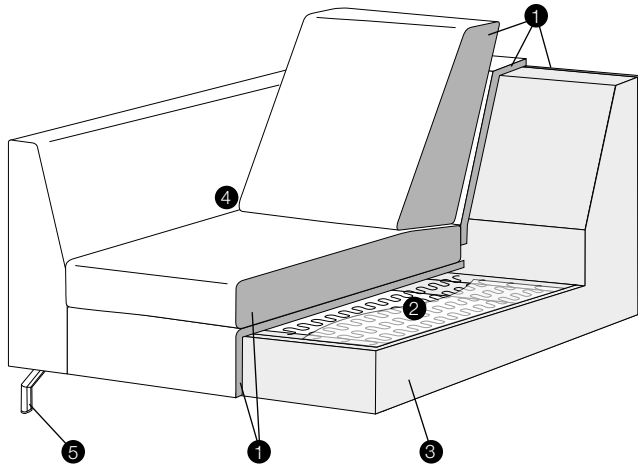

### classic

1. polyurethane foam/high resilient polyurethane foam
2. springs
3. FSC® certified solid wood and wood based elements
4. fabric or leather
5. FSC® certified solid wood or metal legs